



with assistance from
New Zealand Water and Wastes Association
presents

**Managing Stormwater
and Road Run-off
Tools, Techniques and Devices**



Stormwater360



Innovative Stormwater Technologies for Road Runoff

Stormwater Treatment Technologies

- Traditional

- Ponds
- Wetlands
- Swales
- Sand filters



- Innovative

- Screening Devices
- Hydrodynamic Devices
- Filtration Devices

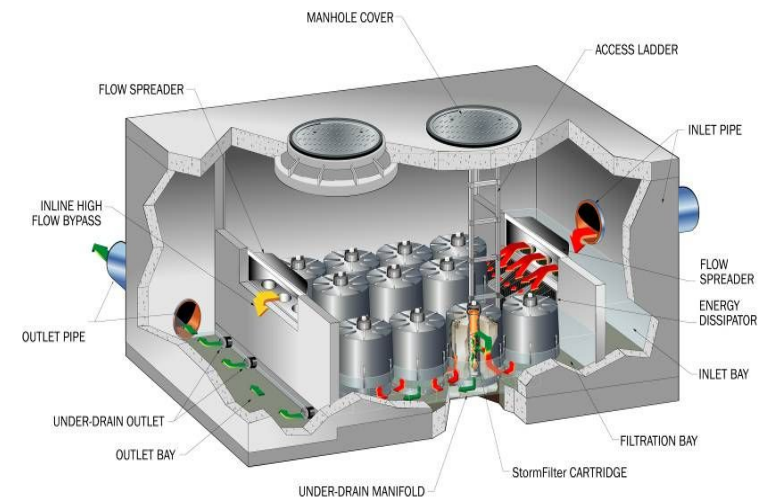

Traditional or Innovative

- Flow based as Opposed to Volume based
- Manufactured Solution as Opposed to Designed and Constructed
- Aboveground or Underground

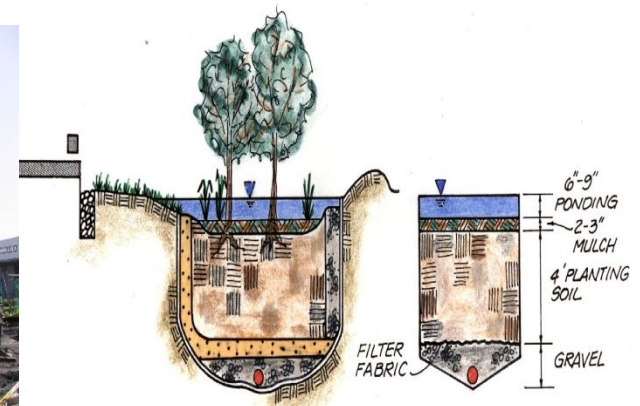
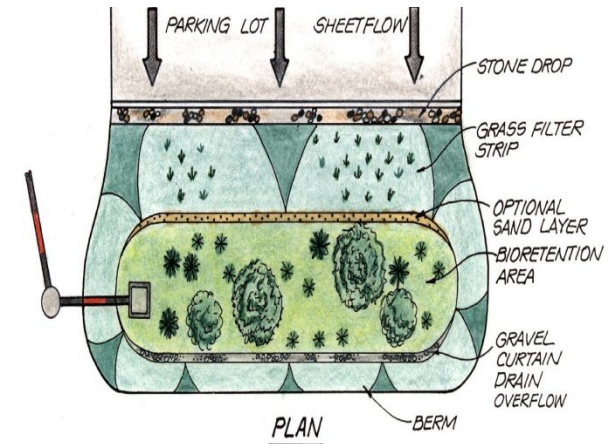

Pollutant Characterization

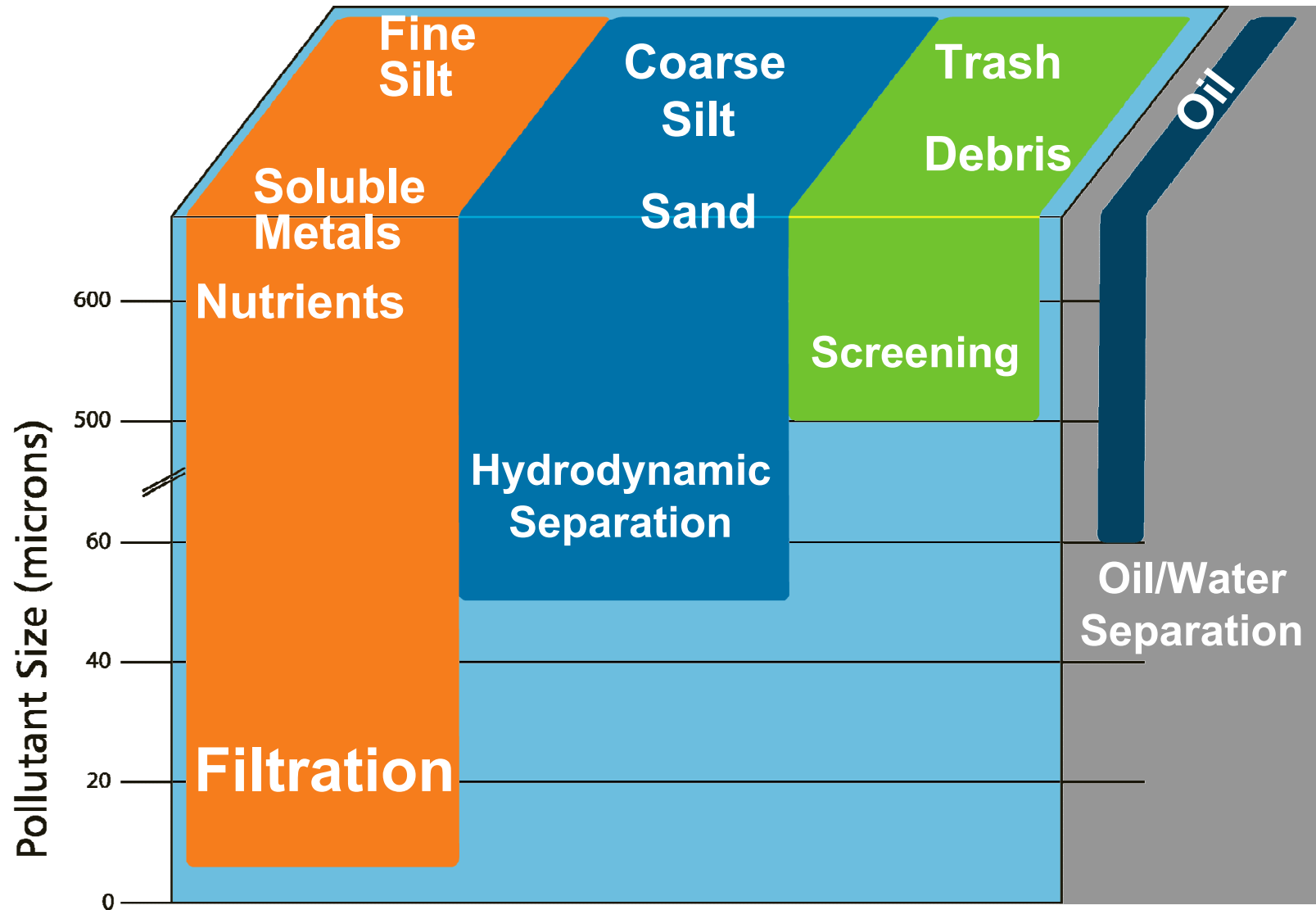

Screening Devices

Why Screening?

Kure Atoll: *Phoebastria immutabilis*, 0.2 X



Victim: Laysan albatross chick. Age: six months. Cause of death: starvation due to a full stomach. Contents of stomach (right): cigarette lighters, pump-top sprayer, nut shells, shotgun shell, broken clothespins, hundreds of plastic bits.

The food an albatross parent regurgitates into a chick's mouth should be squid, fish, and fish eggs. Adults fly thousands of miles to gather this food where it concentrates—in mid-ocean gyres created by currents. But trash trapped in gyres gets gulped down too, then fed to chicks. Before fledging, chicks naturally vomit the squid beaks and other organic undigestibles they've stored. It's rare now to see one of these masses that doesn't contain marine debris. Starvation associated with marine debris is a significant cause of death in chicks that don't fledge.

86 NATIONAL GEOGRAPHIC • OCTOBER 2005



Why Screening?

- Most practical means of capturing neutrally buoyant pollutants
- Ideal for trash and debris removal
- Different screen apertures
- Small footprint for treated flow rate

Screening



Ecosol RSF 4000



CDS

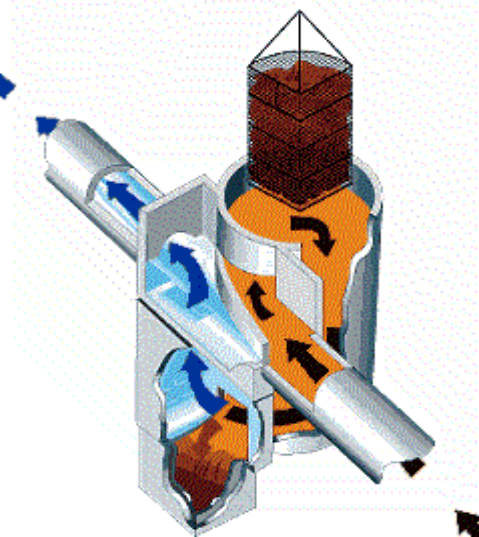

Cleansall

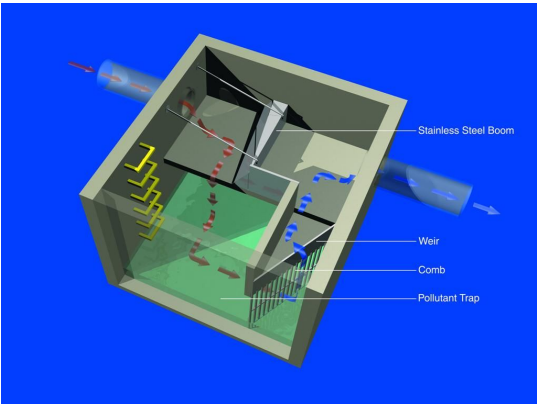

Humegard™

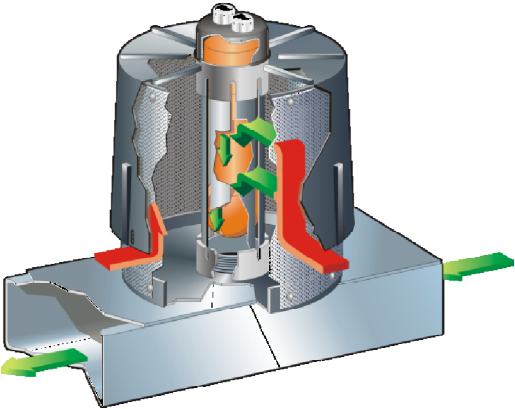

StormScreen®

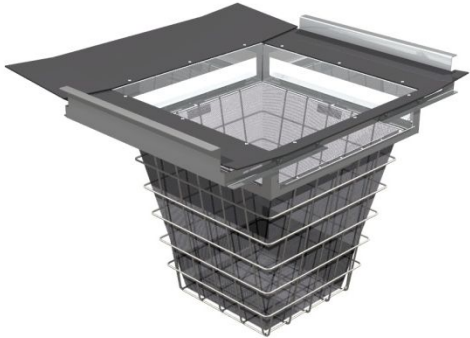

EnviroPod™

Screening Fundamentals

- Specific flow rate (l/sec/m²)
- System hydraulics
- Screen size
- Direct or indirect
- Ease of maintenance
- End-of-pipe systems or catch basin inserts



Where to use Screening devices

- Pre-treatment – One point for maintenance
- Pedestrian areas – Retail areas produce large volumes of gross pollutants
- Retrofit – large visual difference for little cost
- Areas of high organic loads



Questions?

- Mike Hannah, Stormwater 360
- Chris Thorpe, Humes
- Peter Carroll, Hynds
- Keith Caldwell / Sue-Ellen Fenelon, Beca